

ROHS COMPLIANT

Coaxial D-SUB 3W3 FEMALE Solder Cup

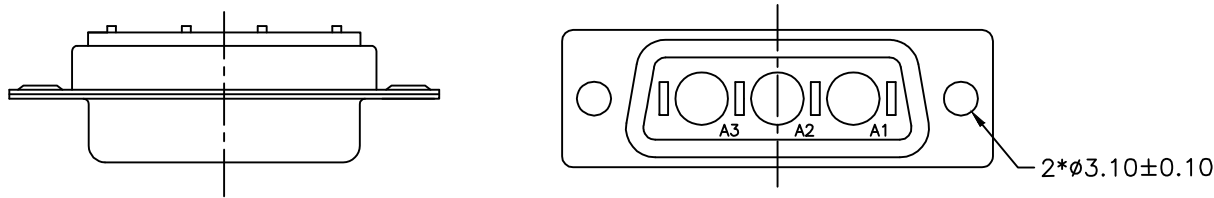

ELECTRICAL CHARACTERISTICS:

Dielectric withstanding Voltage: AC 1000V r.m.s.
 Insulation Resistance: 500 Megohms Minimum at DC 500V
 Contact Resistance: 25 Milliohms
 Operating Temperature: -20°C~+85°C

MATERIALS:

Insulator: PBT, UL 94V-0 Rated
 Shell: Cold Roller Steel

Ordering Code:

PDC3W3 -F -G0 -B -X -00
 ① ② ③ ④ ⑤ ⑥

- ① Series
- ② Contact Type:
M:Male F:Female
- ③ Contact NO. :
G0: Gold flash G1: 3u" Gold
G2: 5u" Gold G3: 10u" Gold
G4: 15u" Gold G5: 30u" Gold
- ④ Insulation Color Code:
B:Black L:Blue
W:White
- ⑤ Mounting Option:
A: Through-hole
B: 2.55" Threaded insert
C: 6.80" Threaded rear spacer
D: 10.3" Threaded rear spacer
E: 11.0" Threaded rear spacer
F: 11.9" Threaded rear spacer
PCB clip
- ⑥ Series

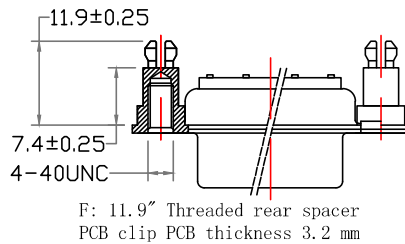
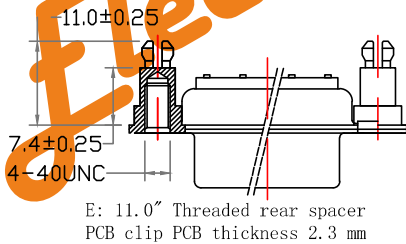
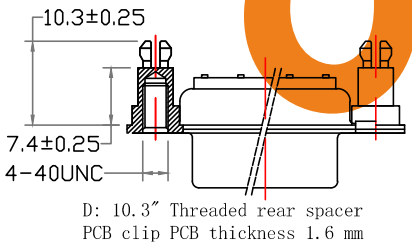
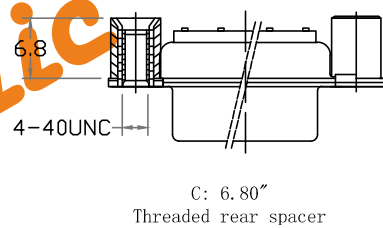
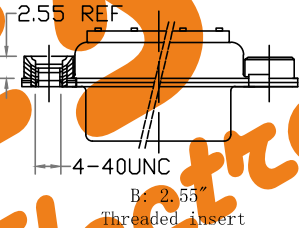
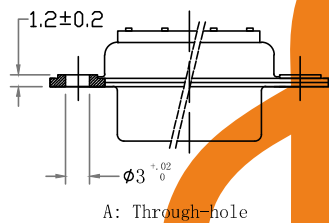
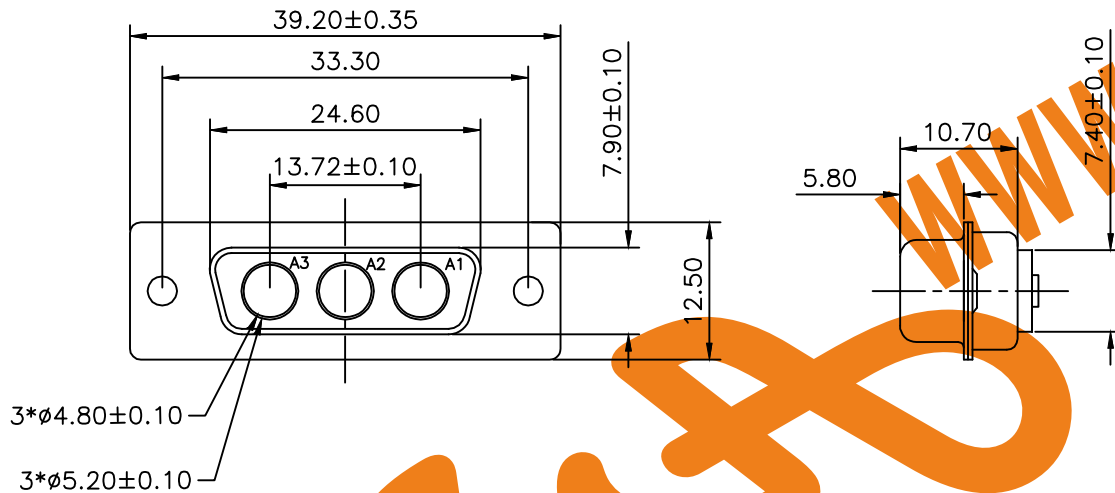

Unless Otherwise specified tolerance
 X.±0.35
 X.X:±0.25
 X.XX:±0.20
 X.XXX:±0.15



ASA Electronic Co.
 Tel : (+98) 21 66 73 56 82 Mob : (+98) 912 03 161 02

SCALE: 1:1 UNIT: mm
 DRAWN: junfon H
 CHECKED: YANG

TITLE:
 Coaxial D-SUB 3W3 FEMALE Solder Cup

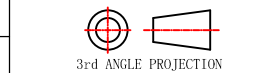

DRAWING NO: PDC3W3-FXXXXX00
 PRODUCT NO: PDC3W3-FXXXXX00

REV	DESCRIPTION	DATE
	Add option of plating	12/7/17